

Hinge door

Installation instructions

R-QP-F80/F90/F100

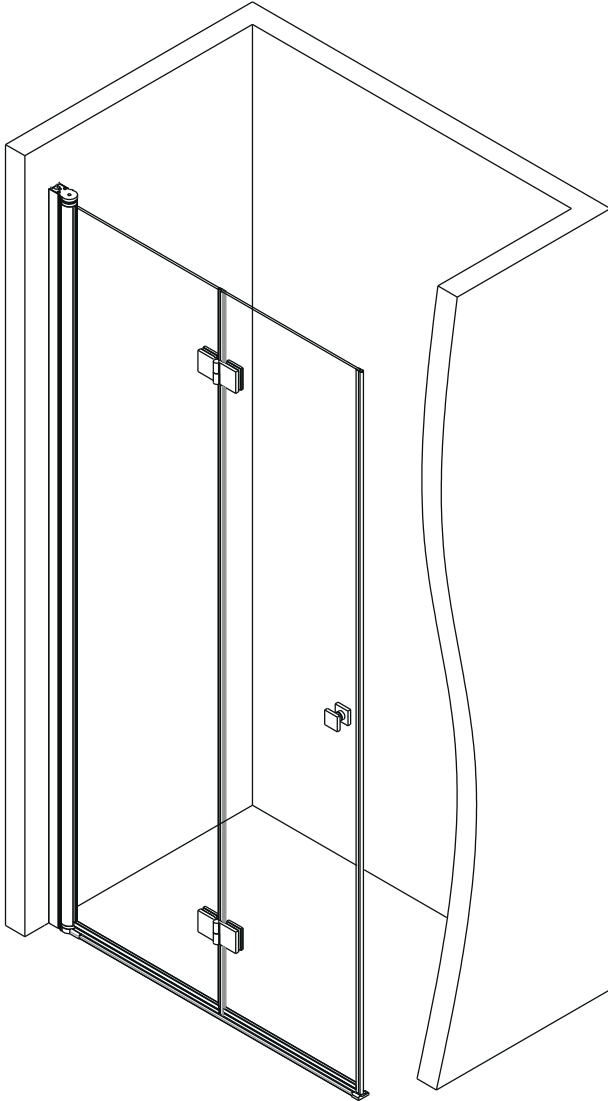

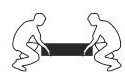
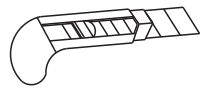
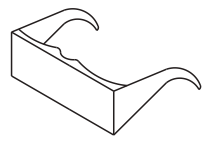
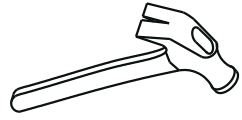
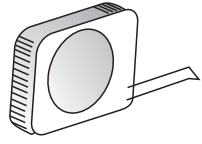
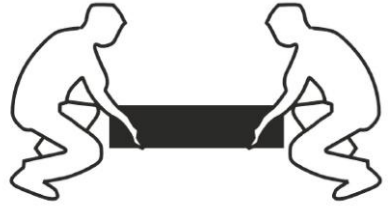
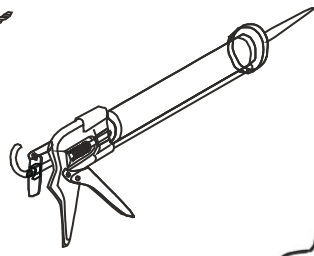
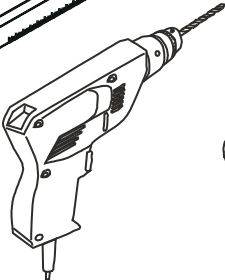
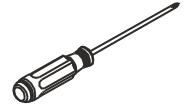
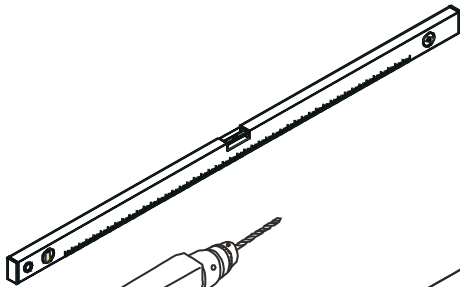

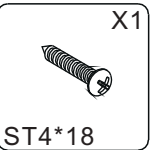
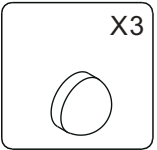
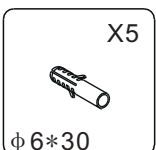
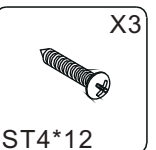
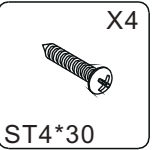
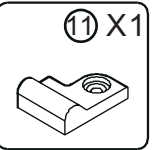
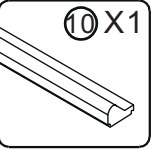
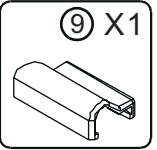
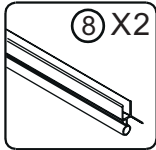
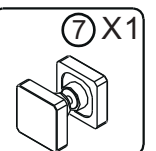
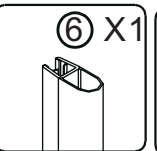
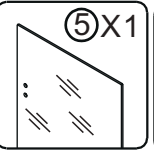
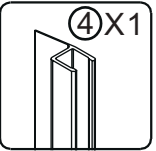
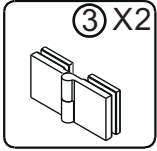
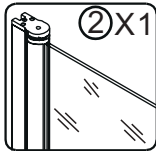
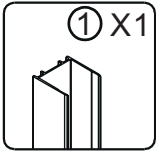
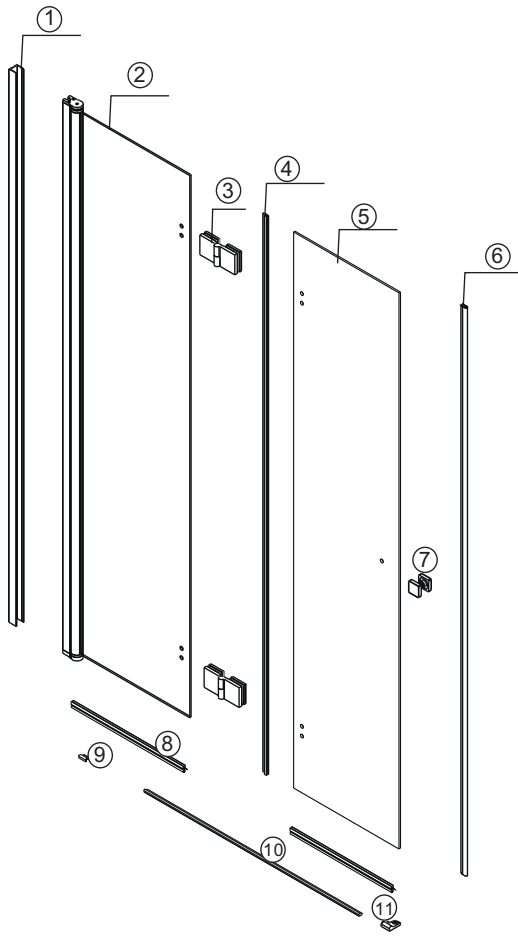

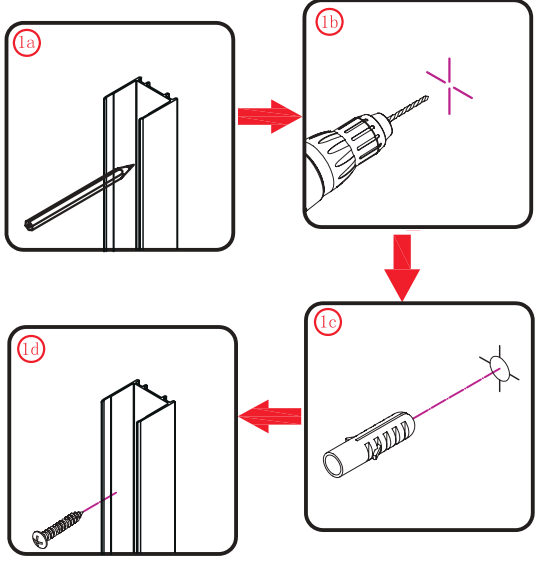
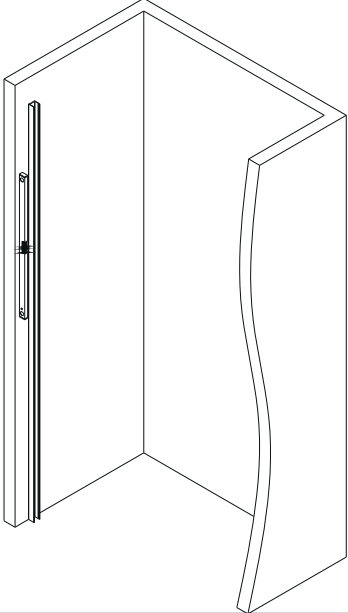

$\phi 6\text{mm}$ $\phi 6*30$ ST4*30

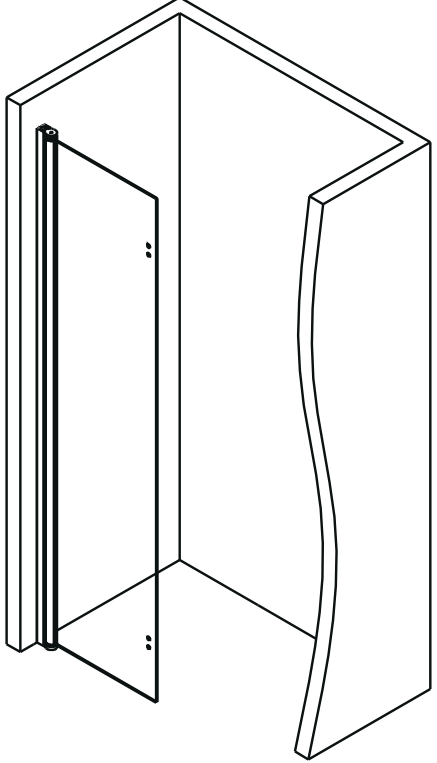
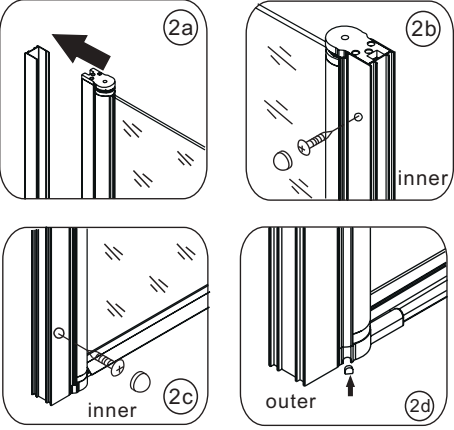

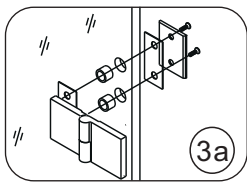

3a

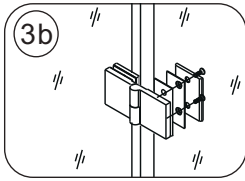

3b

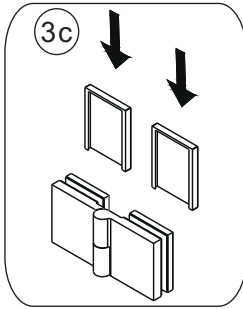

3c

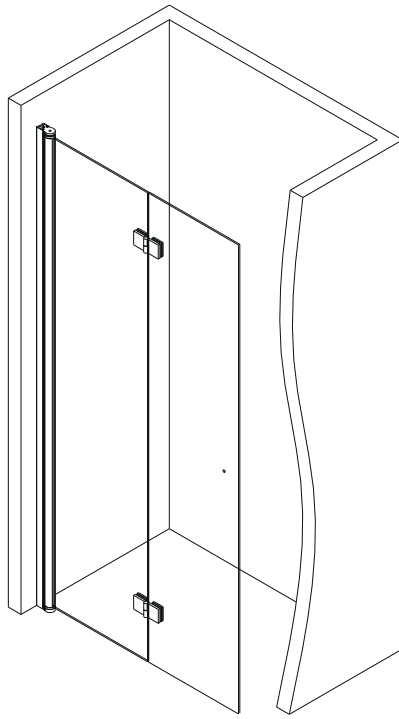

4

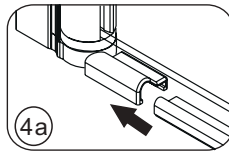
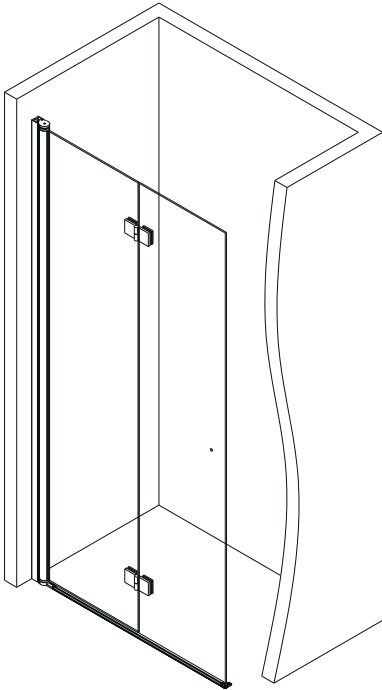

4a

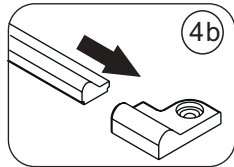

4b

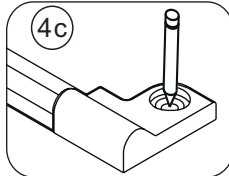

4c

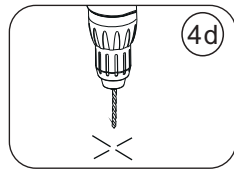

4d

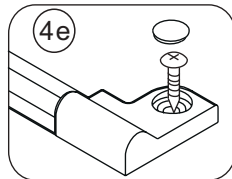

4e

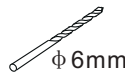

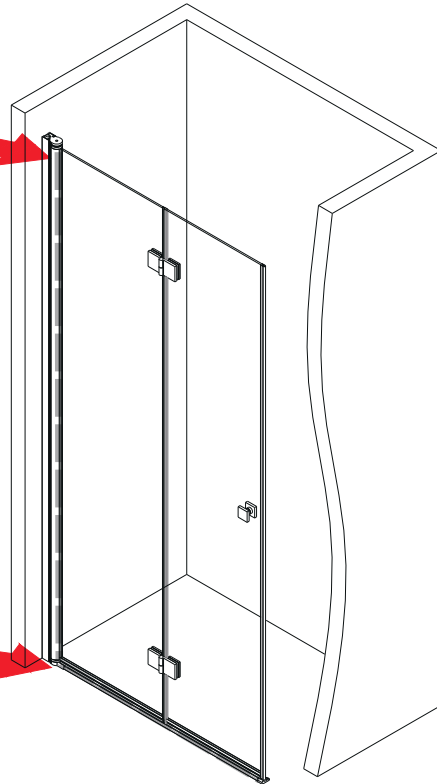
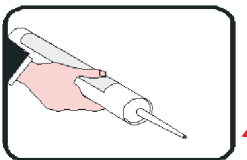
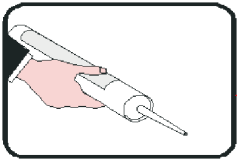
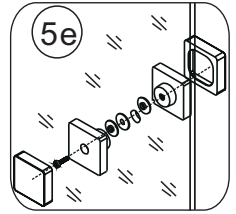
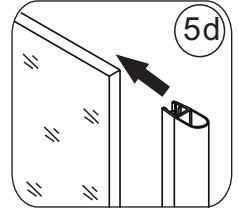
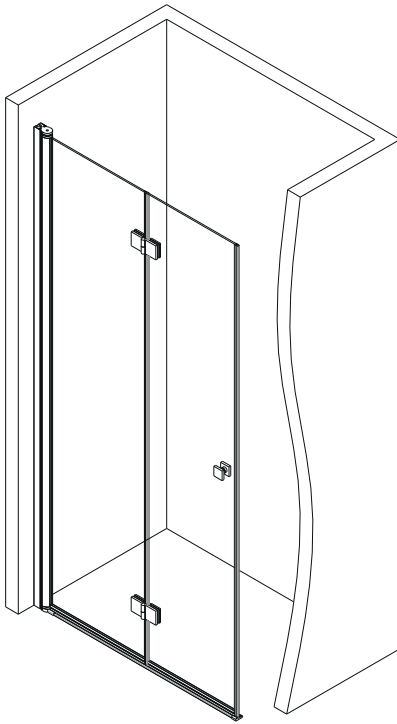
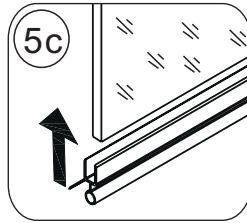
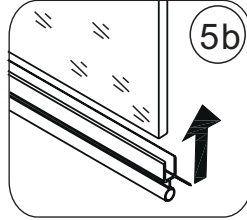
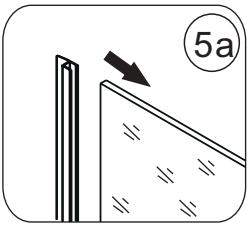

Cleaning & Maintenance

- Clean the sundries once the drain be jamed.
- Normally, clean the shower enclosure by mop with mild detergent or soap.
- Don't clean the shower enclosure with irritant detergent, alcohol, gasoline or other chemical cleaner.
- Should there have any dirty stains on the shower enclosure, you may clean it with vinegar of low density, but you must clean it with water afterwards.